

# Service manual GS20-ED

**Version: 2.00**

**Ident:**

**Series:**

**Part-Number: 102711**

**This part can be ordered.**



## Chapter

add-on kit / construction kit Prover 20-ED - V:

door Prover20-ED - V:

frame Prover 20-ED - V:

102624 - operating unit IS 500 Prover 20-ED - V:

102623 - operating unit IS 600 Prover 20-ED - V:

102719 - operating unit Prover MAN complete Prover 20-ED - V:

tray runners Prover20-ED complete (2x10) - V:

102650 - water-energy unit Prover 20-ED-IS complete - V:

102716 - water-energy unit Prover 20-ED-MAN complete 230V 50Hz - V:

# Service manual add-on kit / construction kit Prover 20-ED

**Version:**

**Ident:**

**Series:**

**Part-Number:**



## Chapter

66055 - construction kit solenoid valva Prover 20-ED - V:  
103523 - water-energy unit\_NR for Prover 20-ED-MAN - V:  
103522 - water-energy unit\_NR for Prover-ED-IS - V:



**PLATON SERVICE**  
8 (800) 500-34-47  
[www.platonservice.com](http://www.platonservice.com)

# Service manual construction kit solenoid valva Prover 20-ED

**Version:**

**Ident:**

**Series:**

**Part-Number: 66055**

**This part can be ordered.**



## Chapter

- [010] - 100138 - hose clamp Cobra 17/8; Attention replaced by 42237
- [010] - 42237 - hose clamp 12-22/9A1
- [020] - 33524 - HT - hose silicone D 18xS3 LW12
- [030] - 33358 - hose connection G1/4"
- [040] - 33560 - gasket ring copper
- [050] - 33350 - brass angle
- [060] - 103330 - nozzle to lead the diaphragm through for safety temperature limiter
- [070] - 103550 - solenoid valve

**Part: hose clamp Cobra 17/8; Attention replaced by 42237**

**Part-Number: 100138**



---

**Part: hose clamp 12-22/9A1**

**Part-Number: 42237**



---

**Part: HT - hose silicone D 18xS3 LW12**

**Part-Number: 33524**



---

**Part: hose connection G1/4"**

**Part-Number: 33358**





## Part: gasket ring copper

Part-Number: 33560



## Part: brass angle

Part-Number: 33350



## Part: nozzle to lead the diaphragm through for safety temperature limiter

Part-Number: 103330

To reset the safety temperature limit switch the fan cover which is found in the interior of the proofer must be removed. The knob is protected from spray and steam under a membrane case. By firmly pressing the covered key the safety temperature limit can be re-set. Please note that the STB does not activate without reason!



## Part: solenoid valve

**Part-Number: 103550**

It is necessary to clean the dirt sieve of the solenoid valve regularly. Particles in the water line will stick to the sieve and interrupt the water flow. Please note the maximum water pressure and other warnings from the data sheets regarding the water connection. The solenoid valve is a valve for the steaming filler as well as for the automatic cleaning process Pro Clean. The solenoid valve works with a flow pressure of 150 - 600 kPa. You can test the solenoid valve function in the PC - Tool - Test. Attention the test is a continued test and this function is not protected from overload.



**PLATON SERVICE**

8 (800) 500-34-47

[www.platonservice.com](http://www.platonservice.com)

# Service manual water-energy unit\_NR for Prover 20-ED-MAN

**Version:**

**Ident:**

**Series:**

**Part-Number: 103523**

**This part can be ordered.**



## Chapter

[010] - 103112 - vice action latch (door)  
[020] - 103551 - heating 2000 W



PLATON SERVICE  
8 (800) 500-34-41  
www.platonservice.com

## Part: vice action latch (door)

**Part-Number: 103112**

If the door lock needs to be re set. loosen the screws around the door latch. Thanks to the slotted holes the door can be easily adjusted. Only a correctly aligned door can guarantee the necessary door seal which results in optimal proofing.



---

## Part: heating 2000 W

**Part-Number: 103551**

We recommend when installing the heater the securing screws are non-threading. Please make sure the heater is correctly situated so that the securing attachments fit through the fan wheel to be connected.



# Service manual water-energy unit\_NR for Prover-ED-IS

Version:

Ident:

Series:

Part-Number: 103522

This part can be ordered.



## Chapter

- [010] - 103112 - vice action latch (door)
- [020] - 103551 - heating 2000 W
- [030] - 103477 - sealing plate
- [040] - 102651 - vaporizer



## Part: vice action latch (door)

**Part-Number: 103112**

If the door lock needs to be re set, loosen the screws around the door latch. Thanks to the slotted holes the door can be easily adjusted. Only a correctly aligned door can guarantee the necessary door seal which results in optimal proofing.



## Part: heating 2000 W

**Part-Number: 103551**

We recommend when installing the heater the securing screws are non-threading. Please make sure the heater is correctly situated so that the securing attachments fit through the fan wheel to be connected.



## Part: sealing plate

**Part-Number: 103477**



**Part: vaporizer**

**Part-Number: 102651**



**PLATON SERVICE**

8 (800) 500-34-47

[www.platonservice.com](http://www.platonservice.com)



# Service manual door Prover20-ED

**Version:**

**Ident:**

**Series:**

**Part-Number:**



## Chapter

- [010] - 105047 - Door right GS2-ED
- [011] - 105039 - Door glued ST right
- [012] - 105045 - Door right with cutout GS2-ED
- [014] - 111824 - Door ST right nostalgia
- [015] - 105037 - Door right glued GS2
- [016] - 111825 - Door right GS2 nostalgia
- [020] - 105046 - Door, left GS2-ED
- [021] - 105038 - Door glued left ST
- [022] - 105044 - Door, left with cutout GS2-ED
- [024] - 111823 - Door left ST GS2 nostalgia
- [025] - 105036 - Door left glued GS2
- [026] - 111826 - Door left GS2 nostalgia
- [030] - 103219 - Door BM opaque
- [031] - 103220 - door, opaque for GS20-ED with cutout for control
- [032] - 103221 - door, opaque for GS20-ED
- [040] - 102807 - vice action latch (door)
- [050] - 102808 - handle GS20/GS2-ED
- [060] - 102812 - bush bearing
- [070] - 34297 - plug (door)
- [080] - 102743 - cover
- [090] - 102531 - hinge pin
- [091] - 104420 - hinge pin



## Part: Door right GS2-ED

Part-Number: 105047



---

## Part: Door glued ST right

Part-Number: 105039



PLATON SERVICE  
8 (800) 500-5147  
www.platonservice.com

**Part: Door right with cutout GS2-ED**

Part-Number: 105045

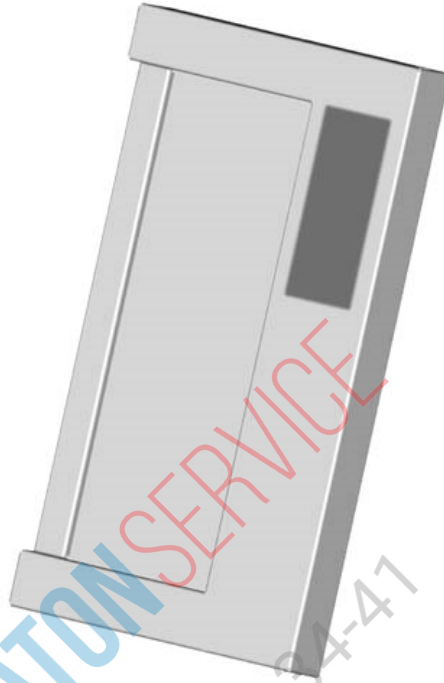

---

**Part: Door ST right nostalgia**

Part-Number: 111824

---

**Part: Door right glued GS2**

Part-Number: 105037

---

**Part: Door right GS2 nostalgia**

Part-Number: 111825

---

**Part: Door, left GS2-ED**

**Part-Number: 105046**



---

**Part: Door glued left ST**

**Part-Number: 105038**



PLATON SERVICE  
8 (800) 500-34-47  
www.platonservice.com

**Part: Door, left with cutout GS2-ED**

Part-Number: 105044

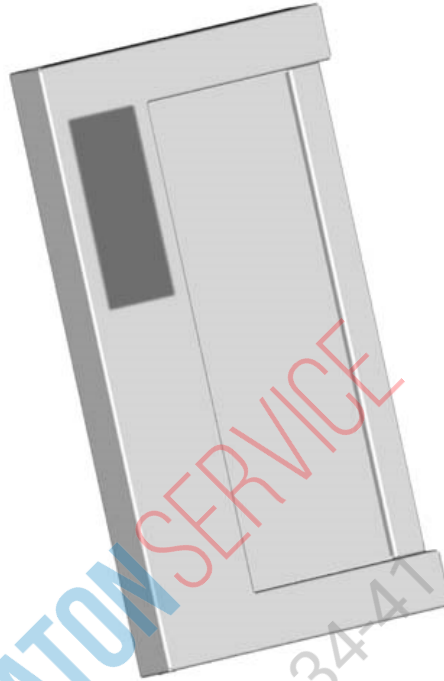

---

**Part: Door left ST GS2 nostalgia**

Part-Number: 111823

---

**Part: Door left glued GS2**

Part-Number: 105036

---

**Part: Door left GS2 nostalgia**

Part-Number: 111826

---

**Part: Door BM opaque**

Part-Number: 103219

---

**Part: door, opaque for GS20-ED with cutout for control**

Part-Number: 103220

---

## Part: door, opaque for GS20-ED

Part-Number: 103221

---

## Part: vice action latch (door)

Part-Number: 102807

If the door lock needs to be re set. loosen the screws around the door latch. Thanks to the slotted holes the door can be easily adjusted. Only a correctly aligned door can guarantee the necessary door seal which results in optimal proofing.



## Part: handle GS20/GS2-ED

Part-Number: 102808

To prevent damage ensure that both door handles are securely fastened. The door handle is secured with screw M4X10 article number 42392 and washer article number 42209. Additionally the handle is secured with Locite 243 article number 61905.



## Part: bush bearing

Part-Number: 102812

To ensure the proofer door opens and closes properly check the door bearings.



---

## Part: plug (door)

Part-Number: 34297



---

## Part: cover

Part-Number: 102743

---

## Part: hinge pin

Part-Number: 102531



---

## Part: hinge pin

Part-Number: 104420

---

# Service manual frame Prover 20-ED

Version:

Ident:

Series:

Part-Number:

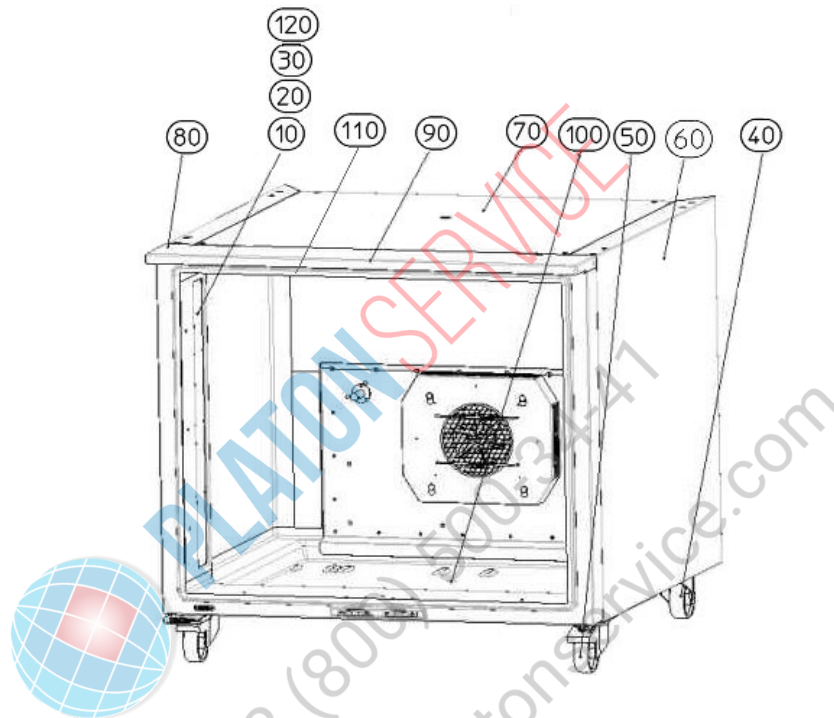

## Chapter

- [010] - 102567 - halogen socket
- [020] - 109916 - halogen lamp 10W 12V; Attention replace by 101731. Not applicable for provers!
- [030] - 33042 - porcelain clamp 2-pole 10A
- [040] - 105586 - castor; Attention replaced by 9050-110-004
- [040] - 9050-110-004 - castor
- [050] - 105585 - castor with arresting device => Attention, replaced by 9050-110-003
- [050] - 9050-110-003 - castor with arresting device
- [060] - 102646 - Side panel GS20-ED
- [070] - 102823 - cover
- [080] - 102733 - panel
- [090] - 103112 - vice action latch (door)
- [100] - 36149 - plug for water tray
- [110] - 38605 - door seal
- [120] - 0700-001-010 -

## Part: halogen socket

**Part-Number: 102567**

Check the porcelain lamp holders and cables for damage. Please do not squeeze or kink the cable.



---

## Part: halogen lamp 10W 12V; Attention replace by 101731. Not applicable for prowers!

**Part-Number: 109916**

---

## Part: porcelain clamp 2-pole 10A

**Part-Number: 33042**

Check the porcelain lamp holders and cables for damage. Please do not squeeze or kink the cable.



---

## Part: castor; Attention replaced by 9050-110-004

**Part-Number: 105586**

---



## Part: castor

Part-Number: 9050-110-004

To allow a simple driving out for maintenance, the wheels should be positioned in the direction of motion so that the wheels do not get stuck.



---

**Part: castor with arresting device => Attention, replaced by 9050-110-003**

Part-Number: 105585

---

**Part: castor with arresting device**

Part-Number: 9050-110-003

To allow a simple driving out for maintenance, the wheels should be positioned in the direction of motion so that the wheels do not get stuck.



---

**Part: Side panel GS20-ED**

Part-Number: 102646

---

**Part: cover**

Part-Number: 102823

---

## Part: panel

Part-Number: 102733



---

## Part: vice action latch (door)

Part-Number: 103112

If the door lock needs to be re set, loosen the screws around the door latch. Thanks to the slotted holes the door can be easily adjusted. Only a correctly aligned door can guarantee the necessary door seal which results in optimal proofing.



---

## Part: plug for water tray

Part-Number: 36149

The plug in the water tub seals the cleaning opening of the proofer. To maintain an optimal climate in the proofer it is necessary to make sure that the plug is always closed when operating the proofer.



## Part: door seal

**Part-Number: 38605**

The door seal is glued with transparent heat resistant silicone (order number 60375) around the radii on the corners and long distances in between. Should the door seal be exchanged then all the silicone must be removed by using a knife. Clean the door tracks and any silicone particles. Make sure when placing the new seal that it is completely in the frame. The seal needs to be pressed around the connecting piece on the top and bottom and in front of the oven with a broach so that it can "breathe". The door seal is a spare part and can be ordered under the number 38605.



---

## Part:

**Part-Number: 0700-001-010**



PLATON SERVICE

8 (800) 566-574-41  
www.platonservice.com

# Service manual operating unit IS 500 Prover 20-ED

**Version:**

**Ident:**

**Series:**

**Part-Number: 102624**

**This part can be ordered.**

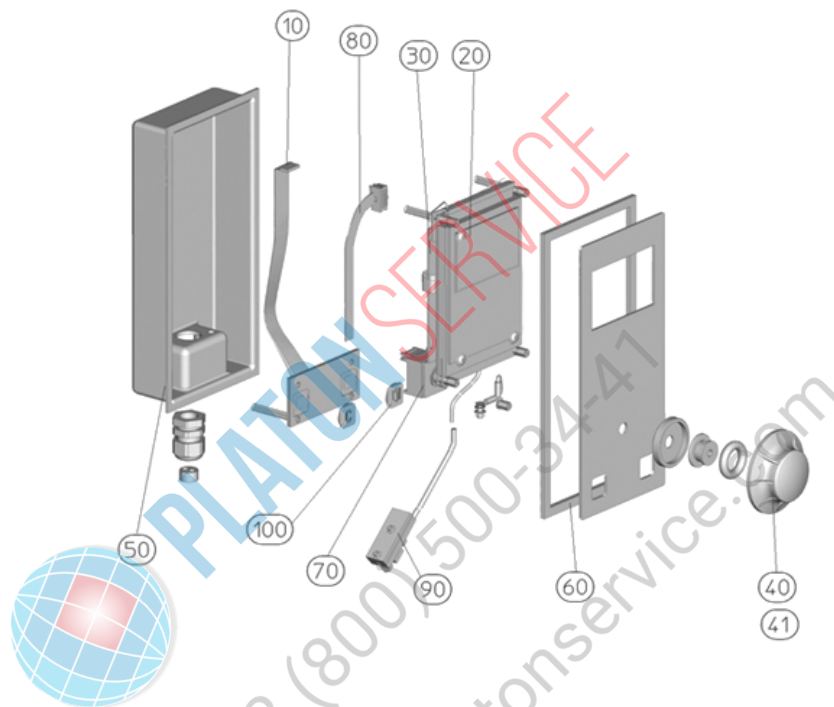

## Chapter

- [010] - 101563 - key block
- [020] - 100804 - display IS500 with circuit board
- [030] - 105564 - electronic circuit board IS500
- [040] - 102685 - knob grey
- [041] - 101350 - knob silver
- [050] - 102450 - frame IS
- [060] - 102449 - seal for frame IS
- [070] - 100591 - incremental encoder
- [080] - 104353 - ribbon cable for IS500
- [090] - 102806 - USB port with data wire

## Part: key block

**Part-Number: 101563**

Ensure that the all contact to the connector is clean and free of grease. Its function can be tested with the Wiesheu PC-Tool/Test/Navigate.



---

## Part: display IS500 with circuit board

**Part-Number: 100804**

This article has been replaced by Articles 104 771, but is not fully compatible. Please follow the spare part instruction "EH\_196-0511-005 Display IS500"



## Part: electronic circuit board IS500

**Part-Number: 105564**

When exchanging the electronic circuit board, please note that electrostatic charge and its components can cause major damage. Therefore please make sure that before coming in contact with the circuit board that the circuit board and its metal frame are completely discharged. Check the DIP - switch setting and the input resistance as in the enclosed document. If interference occurs when transferring data from the PC to the Control ( dark display ), use a flash cable and the programs flash writer to re-write the program. Read the operating-instructions for "Flash-Tool".

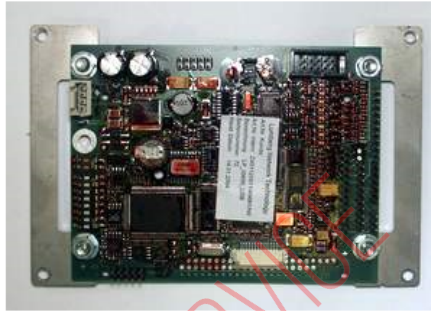

## Part: knob grey

**Part-Number: 102685**

Depending on the version, the button "silver" or "grey" is used.



## Part: knob silver

**Part-Number: 101350**

Depending on the version, the button "silver" or "grey" is used.



## Part: frame IS

**Part-Number: 102450**

Check that all securing screws are present on the frame. In addition check the grounding to frame connection



---

## Part: seal for frame IS

**Part-Number: 102449**

The seal must be correctly installed to avoid moisture admittance.



---

## Part: incremental encoder

**Part-Number: 100591**

Check the incremental sensor using the function test in PC-Tool. To recall function test read the documents to the article.





## Part: ribbon cable for IS500

**Part-Number: 104353**

The ribbon cable connects the circuit board IS 600 and the display. The ribbon cable has a plug on both sides. Ensure that the ribbon cable does not twist or kink.



---

## Part: USB port with data wire

**Part-Number: 102806**

USB interface with USB connection "B". Data interface to PC.





# Service manual operating unit IS 600 Prover 20-ED

Version:

Ident:

Series:

Part-Number: 102623

This part can be ordered.

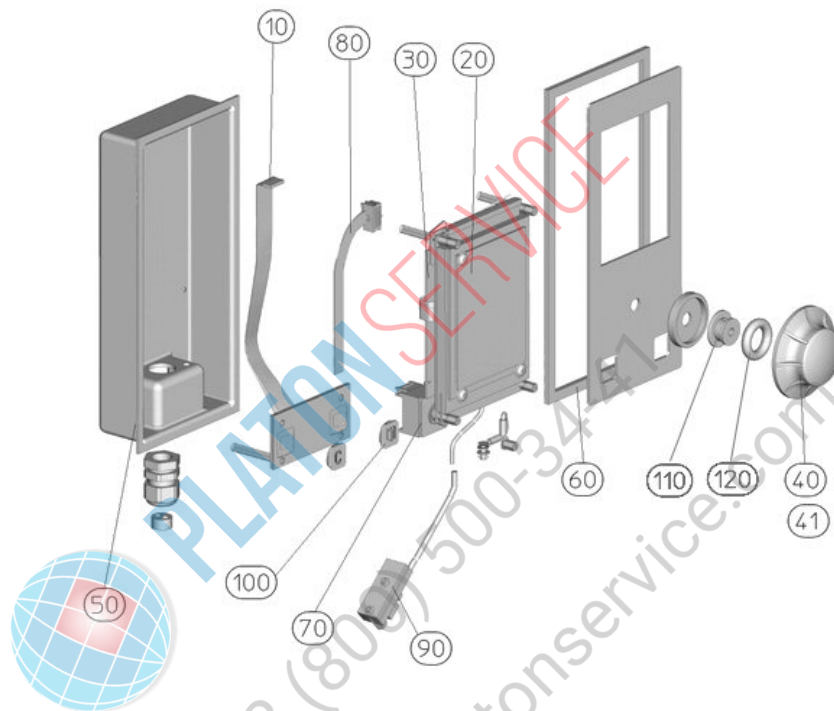

## Chapter

- [010] - 101563 - key block
- [020] - 100617 - display IS600 with circuit board
- [030] - 101107 - electronic circuit board IS600
- [040] - 102685 - knob grey
- [041] - 101350 - knob silver
- [050] - 102450 - frame IS
- [060] - 102449 - seal for frame IS
- [070] - 100591 - incremental encoder
- [080] - 104354 - ribbon cable for IS600
- [090] - 102806 - USB port with data wire
- [110] - 101434 - adapter\_D54x22
- [120] - 101435 - O-ring\_D16x7\_NBR60

## Part: key block

**Part-Number: 101563**

Ensure that the all contact to the connector is clean and free of grease. Its function can be tested with the Wiesheu PC-Tool/Test/Navigate.

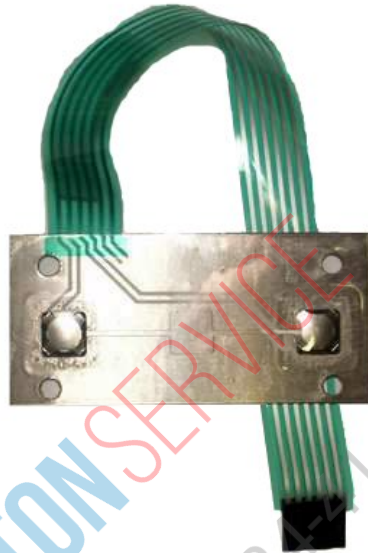

---

## Part: display IS600 with circuit board

**Part-Number: 100617**

Ensure that the all contact to the connector is clean and free of grease. Adjust the contrast of the screen to the surrounding area. Set the contrast by going to "Settings" - "Appliance Settings" - "Display" - "Contrast".



## Part: electronic circuit board IS600

**Part-Number: 101107**

When exchanging the electronic circuit board, please note that electrostatic charge and its components can cause major damage. Therefore, please make sure that before coming in contact with the circuit board that the circuit board and its metal frame are completely discharged. Check the DIP - switch setting and the input resistance as in the enclosed document. If interference occurs when transferring data from the PC to the Control ( dark display ), use a flash cable and the programs flash writer to re-write the program. Read the instructions about part documents.



---

## Part: knob grey

**Part-Number: 102685**

Depending on the version, the button "silver" or "grey" is used.



---

## Part: knob silver

**Part-Number: 101350**

Depending on the version, the button "silver" or "grey" is used.



## Part: frame IS

**Part-Number: 102450**

Check that all securing screws are present on the frame. In addition check the grounding to frame connection



---

## Part: seal for frame IS

**Part-Number: 102449**

The seal must be correctly installed to avoid moisture admittance.



---

## Part: incremental encoder

**Part-Number: 100591**

Check the incremental sensor using the function test in PC-Tool. To recall function test read the documents to the article.



---

## Part: ribbon cable for IS600

**Part-Number: 104354**

The ribbon cable connects the circuit board IS 600 and the display. The ribbon cable has a plug on both sides. Ensure that the ribbon cable does not twist or kink.



## Part: USB port with data wire

**Part-Number: 102806**

USB interface with USB connection "B". Data interface to PC.



---

## Part: adapter\_D54x22

**Part-Number: 101434**



---

## Part: O-ring\_D16x7\_NBR60

**Part-Number: 101435**



# Service manual operating unit Prover MAN complete Prover 20-ED

**Version:**

**Ident:**

**Series:**

**Part-Number: 102719**

**This part can be ordered.**

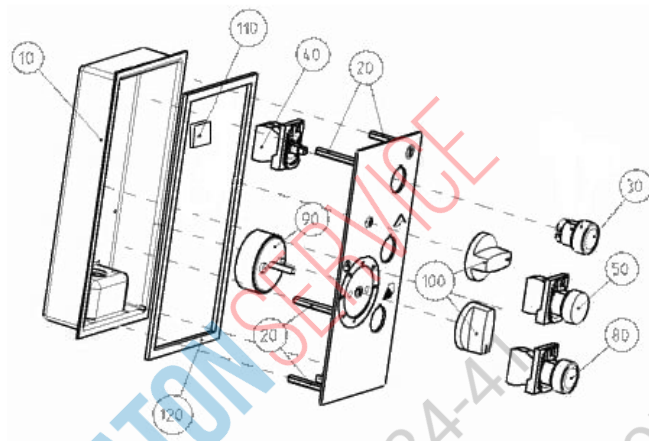

## Chapter

- [010] - 102450 - frame IS
- [020] - 101864 - distance bolt
- [030] - 102523 - push button illuminated
- [040] - 102524 - supporting switch block ZB AWM OM11
- [050] - 102522 - indicator light "white"
- [080] - 102521 - push button XB 5SS21 black
- [090] - 33576 - timer 60 minutes
- [100] - 38898 - knob
- [110] - 103023 - thermostat 0-45°C
- [120] - 102449 - seal for frame IS

## Part: frame IS

**Part-Number: 102450**

Check that all securing screws are present on the frame. In addition check the grounding to frame connection



---

## Part: distance bolt

**Part-Number: 101864**



---

## Part: push button illuminated

**Part-Number: 102523**





**Part: supporting switch block ZB AWM OM11**

**Part-Number: 102524**



**Part: indicator light "white"**

**Part-Number: 102522**



**Part: push button XB 5SS21 black**

**Part-Number: 102521**





## Part: timer 60 minutes

Part-Number: 33576



## Part: knob

Part-Number: 38898



## Part: thermostat 0-45°C

Part-Number: 103023

The thermostat measures the temperature in the baking chamber. The measurement comes from the fluid-filled capillary tubes. Do not kink the wire of the capillary tube when inserting this; it will lead to a false reading of the temperature. Insulate the capillary tube on its critical spots (e.g. on the circuit boards) with silicone hose Article 40074.



## Part: seal for frame IS

**Part-Number: 102449**

The seal must be correctly installed to avoid moisture admittance.



**PLATON SERVICE**

8 (800) 500-34-47

[www.platonservice.com](http://www.platonservice.com)

# Service manual tray runners Prover20-ED complete (2x10)

**Version:**

**Ident:**

**Series:**

**Part-Number:**

## Chapter

[001] - 102551 - tray runners GS2-ED complete (2x10)

[010] - 103024 - tray runners GS-ED, 10 trays left

[020] - 103025 - tray runners GS-ED, 10 trays right



**PLATON SERVICE**

8 (800) 500-34-47

[www.platonservice.com](http://www.platonservice.com)

## Part: tray runners GS2-ED complete (2x10)

Part-Number: 102551

---

## Part: tray runners GS-ED, 10 trays left

Part-Number: 103024

To remove the racks. lift the bottom of the rack upwards. over the plastic securing brackets and pull out sideways. To insert the racks. hook them into the top plastic fasteners first and then affix them to the bottom plastic fasteners.

---

## Part: tray runners GS-ED, 10 trays right

Part-Number: 103025

To remove the racks. lift the bottom of the rack upwards. over the plastic securing brackets and pull out sideways. To insert the racks. hook them into the top plastic fasteners first and then affix them to the bottom plastic fasteners.

---



PLATON SERVICE  
8 (800) 500-34-41  
www.platonservice.com

# Service manual water-energy unit Prover 20-ED-IS complete

**Version:**

**Ident:**

**Series:**

**Part-Number: 102650**

**This part can be ordered.**

## Chapter

- 102859 - vaporizer
- [010] - 102641 - rear panel
- [020] - 34286 - solenoid valve
- [030] - 34675 - water flow detector
- [050] - 102530 - screwing with spray nozzle
- [060] - 103076 - ventilation cover
- [070] - 34306 - enclosure
- [080] - 38400 - loudspeaker
- [090] - 34912 - semi-conductor relay 1-pole
- [100] - 34344 - heating 2000 W
- [110] - 101106 - power board
- [120] - 36106 - motor
- [130] - 40485 - teflon hose
- [140] - 102015 - cable loom for CAN-Bus
- [150] - 38495 - sensor for temp. and humidity
- [150] - 9030-150-001 -
- [160] - 34092 - line filter 20 VB1
- [170] - 102696 - safety limit switch
- [180] - 34108 - clamp grey 3L 2.5qmm
- [190] - 34109 - clamp 3L blue 280-684
- [200] - 34110 - clamp 3L 2.5qmm 280-687
- [210] - 100840 - transformer
- [220] - 103181 - seal (ferrite)

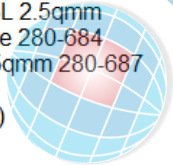

PLATON SERVICE

8 (800) 500-34-47

www.platonservice.com

## Part: vaporizer

**Part-Number: 102859**

Please read the installation instructions for installing the rotation sprayer.



---

## Part: rear panel

**Part-Number: 102641**

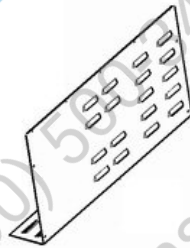

---

## Part: solenoid valve

**Part-Number: 34286**

It is necessary to clean the dirt sieve of the solenoid valve regularly. Particles in the water line will stick to the sieve and interrupt the water flow. Please note that the maximum water pressure and other warnings from the data sheets regarding the water connection.



## Part: water flow detector

**Part-Number: 34675**

Please note when installing the regulator. the color codes and the correct installation. Furthermore the pressure flow regulator must be clean for the water flow to be possible.



---

## Part: screwing with spray nozzle

**Part-Number: 102530**



---

## Part: ventilation cover

**Part-Number: 103076**

Make sure at the end of working with the proofer that the fan cover and safety guard are correctly fastened otherwise there is a risk of injury.

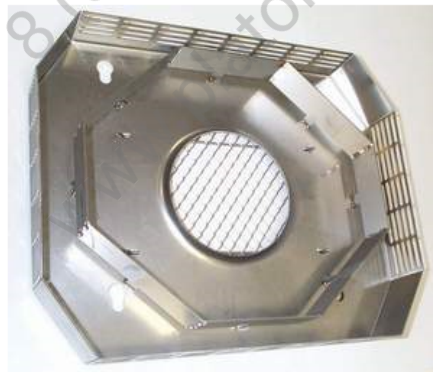



## Part: enclosure

**Part-Number: 34306**

Make sure at the end of working with the proofer that the fan cover and safety guard are correctly fastened otherwise there is a risk of injury.

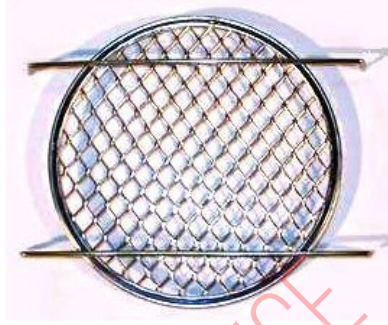

---

## Part: loudspeaker

**Part-Number: 38400**

The loud speaker signal serves as an acoustic signal. For example notification is given for "temperature reached". "end of program". As well as when opening the door a short gong will sound. If the gong does not work, first of all check the appliance settings. You can reach the menu point "Gong" by going to "Settings - Appliance Settings - Gong". Here you can set the volume and intervals of the sound. If the volume and interval is set to 0 no acoustic signal will be given. Test the gong, by going to the PC-Tool - Function Test. Warning! The PC-Tool- Function test is an endurance test and is not protected from overload!



## Part: semi-conductor relay 1-pole

**Part-Number: 34912**

The solid state relay controls the heater. Depending on the temperature this will automatically switch it on or off. ( type can vary )



---

## Part: heating 2000 W

**Part-Number: 34344**

We recommend when installing the heater the securing screws are non-threading. Please make sure the heater is correctly situated so that the securing attachments fit through the fan wheel to be connected.



## Part: power board

**Part-Number: 101106**

Disconnect power before beginning work. This article is fully prepared for servicing purposes. Please read the appropriate "Article Documents". When replacing the electronic circuit board, electrostatic can damage the circuit board and its components. Ensure before handling the electrical circuit board that a grounded metal frame discharges the electrostatic. The electrical circuit board is available as a service circuit board in a complete version under the Order Number 101106 and can also be used in other appliance models. On the circuit board you will find 3 fuses. F2 output L1 (4A tr); F3 output N (4A tr); F4 output transformer 24, 12, 5 V (1,5A tr). The circuit board has Eprom with each current software update and an 8 pole Dip- switch (configurations switch). Attention must be given to which switch the Dip- switch is actively switched. The various switch settings can be found in the assembly instruction.



## Part: motor

**Part-Number: 36106**

For improved baking results the Hanning Motor has two rotating directions and several speeds. In ovens with the IS Control the speed is regulated by the Triac setter. In ovens with a manual control the contactor regulates the speed. The motor is secured with 4 M 6 nuts. The distance sleeves screws that are fixed by locknuts must always have the same height. Tighten the nuts diagonally to avoid tension. The motor has a built in thermo protection (bimetal) that activates at 160° C and automatically resets when cooled down. When the motor protection is activated the motor function is interrupted.



## Part: teflon hose

**Part-Number: 40485**



## Part: cable loom for CAN-Bus

**Part-Number: 102015**

This data cable is to connect additional IS controlled WIESHEU ovens. With multiple appliance operation up to 8 appliances can be connected to each other and operated by a single IS 600 Control. When using the multiple appliance operation a CAN - repeater is required or a phase balance connection X1.3 must be heeded on the power element.



---

## Part: sensor for temp. and humidity

**Part-Number: 38495**

The combi sensor measures the moisture and proofer chamber temperature. When installing make sure the slits are always facing down so that moisture will not settle on the measuring points giving off wrong readings.



## Part:

Part-Number: 9030-150-001



---

## Part: line filter 20 VB1

Part-Number: 34092

The net filter is required to prevent customer sided interference in the net.



## Part: safety limit switch

**Part-Number: 102696**

After transportation of the appliance please note that the safety temperature limiter (STB) automatically releases with temperatures under +8°C. To allow the appliance to acclimatize let it stand for 30 minutes at room temperature before re-setting the STB. The STB can be re-set as often as needed. Please note that the STB does not activate without reason ! Insulate the capillary tube (e.g. on the circuit board) on its critical spots with silicone hose Article number 40074.



---

## Part: clamp grey 3L 2.5qmm

**Part-Number: 34108**



---

## Part: clamp 3L blue 280-684

**Part-Number: 34109**





## Part: clamp 3L 2.5qmm 280-687

Part-Number: 34110



## Part: transformer

Part-Number: 100840

The lighting transformer provides power to the baking chamber. The interior lighting is (2x12V/20W) Please note the wiring when removing/inserting. The wire should not come in contact with the circuit board. This may cause sporadic interference with the electronics.



## Part: seal (ferrite)

Part-Number: 103181

The ferrite case is required to prevent EMV sided interference.



# Service manual water-energy unit Prover 20-ED-MAN complete 230V 50Hz

Version:

Ident:

Series:

Part-Number: 102716

This part can be ordered.

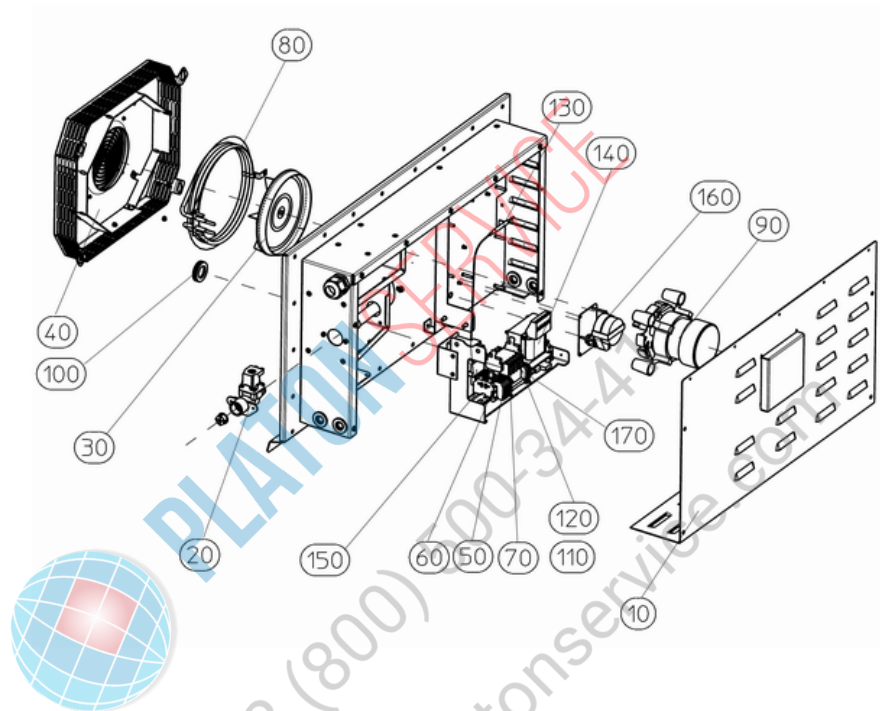

## Chapter

- [010] - 102641 - rear panel
- [020] - 103550 - solenoid valve
- [030] - 103068 - vaporizer
- [040] - 103076 - ventilation cover
- [050] - 34101 - base clamp
- [060] - 34102 - finishing plate
- [070] - 34112 - finishing plate
- [080] - 103551 - heating 2000 W
- [090] - 36106 - motor
- [090] - 36303 - motor 75W; Attention replaced by 36106
- [100] - 38525 - nozzle to lead the diaphragm through
- [110] - 35135 - micro-fuse 2A
- [120] - 34752 - micro-fuse 1A
- [130] - 102696 - safety limit switch
- [140] - 100840 - transformer
- [150] - 38706 - capacitor 3 $\mu$ F
- [160] - 103101 - fan reversing switch
- [170] - 33884 - relay main switch



## Part: rear panel

Part-Number: 102641

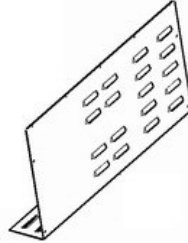

## Part: solenoid valve

Part-Number: 103550

It is necessary to clean the dirt sieve of the solenoid valve regularly. Particles in the water line will stick to the sieve and interrupt the water flow. Please note the maximum water pressure and other warnings from the data sheets regarding the water connection. The solenoid valve is a valve for the steaming filler as well as for the automatic cleaning process Pro Clean. The solenoid valve works with a flow pressure of 150 - 600 kPa. You can test the solenoid valve function in the PC - Tool - Test. Attention the test is a continued test and this function is not protected from overload.



## Part: vaporizer

Part-Number: 103068



## Part: ventilation cover

Part-Number: 103076

Make sure at the end of working with the proofer that the fan cover and safety guard are correctly fastened otherwise there is a risk of injury.



---

## Part: base clamp

Part-Number: 34101

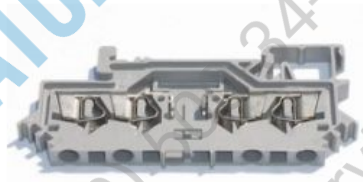

---

## Part: finishing plate

Part-Number: 34102



---

## Part: finishing plate

Part-Number: 34112



## Part: heating 2000 W

**Part-Number: 103551**

We recommend when installing the heater the securing screws are non-threading. Please make sure the heater is correctly situated so that the securing attachments fit through the fan wheel to be connected.



## Part: motor

**Part-Number: 36106**

For improved baking results the Hanning Motor has two rotating directions and several speeds. In ovens with the IS Control the speed is regulated by the Triac setter. In ovens with a manual control the contactor regulates the speed. The motor is secured with 4 M 6 nuts. The distance sleeves screws that are fixed by locknuts must always have the same height. Tighten the nuts diagonally to avoid tension. The motor has a built in thermo protection (bimetal) that activates at 160° C and automatically resets when cooled down. When the motor protection is activated the motor function is interrupted.



## Part: motor 75W; Attention replaced by 36106

**Part-Number: 36303**

The motor is fastened with 4 M5 nuts, diagonally tighten the nuts to prevent tension. Remember that with each motor removal the motor shaft seal must be replaced.



## Part: nozzle to lead the diaphragm through

**Part-Number: 38525**

To reset the safety temperature limit switch the fan cover which is found in the interior of the proofer must be removed. The knob is protected from spray and steam under a membrane case. By firmly pressing the covered key the safety temperature limit can be re-set. Please note that the STB does not activate without reason!



## Part: micro-fuse 2A

**Part-Number: 35135**



## Part: micro-fuse 1A

Part-Number: 34752



## Part: safety limit switch

Part-Number: 102696

After transportation of the appliance please note that the safety temperature limiter (STB) automatically releases with temperatures under  $+8^{\circ}\text{C}$ . To allow the appliance to acclimatize let it stand for 30 minutes at room temperature before re-setting the STB. The STB can be re-set as often as needed. Please note that the STB does not activate without reason! Insulate the capillary tube (e.g. on the circuit board) on its critical spots with silicone hose Article number 40074.



## Part: transformer

Part-Number: 100840

The lighting transformer provides power to the baking chamber. The interior lighting is (2x12V/20W) Please note the wiring when removing/inserting. The wire should not come in contact with the circuit board. This may cause sporadic interference with the electronics.



## Part: capacitor 3 $\mu$ F

Part-Number: 38706



## Part: fan reversing switch

Part-Number: 103101



## Part: relay main switch

Part-Number: 33884

The contactor switches the heater on/off.





## Urheberrecht:

Das Urheberrecht an diesem Servicehandbuch verbleibt bei der WIESHEU GmbH. Dieses Servicehandbuch ist nur für autorisierte Servicepartner und dessen Personal bestimmt. Sie enthält Vorschriften und Hinweise, die weder vollständig noch teilweise vervielfältigt, verbreitet oder anderweitig mitgeteilt werden dürfen.

Alle Darstellungen, Zeichnungen, Bilder Texte und Angaben sind urheberrechtlich geschützt. Sie unterliegen den gewerblichen Schutzrechten.

## Zu diesem Servicehandbuch:

Alle Abbildungen in diesem Dokument sollen die Verständlichkeit unterstützen. Die Abbildungen sind nicht maßstabsgerecht. Teilweise sind dem Originalprodukt ähnelnde Abbildungen dargestellt, die geringfügig abweichen können.

## Achtung!

Vermeiden Sie Fehlfunktionen oder Beschädigungen durch falsche Ersatzteile. Wir empfehlen die ausschließliche Verwendung von WIESHEU-Original-Ersatzteilen.

**Wiesheu GmbH**  
**Daimlerstrasse 10**  
**DE-71563 Affalterbach**  
**Telefon: +49 (0)7144 / 3 03-0**  
**Fax: +49 (0)7144 / 3 03-11**  
**Service-Telefon: 0800-WIESHEU**  
**E-Mail: [info@wiesheu.de](mailto:info@wiesheu.de)**  
**[www.wiesheu.de](http://www.wiesheu.de)**

Stand: 6/19/2015



**PLATON SERVICE**

8 (800) 500-34-47

[www.platonservice.com](http://www.platonservice.com)